

NA SERIES **2" BORE, 1.25"** **ROD CYLINDER** **B PORT POSITION**

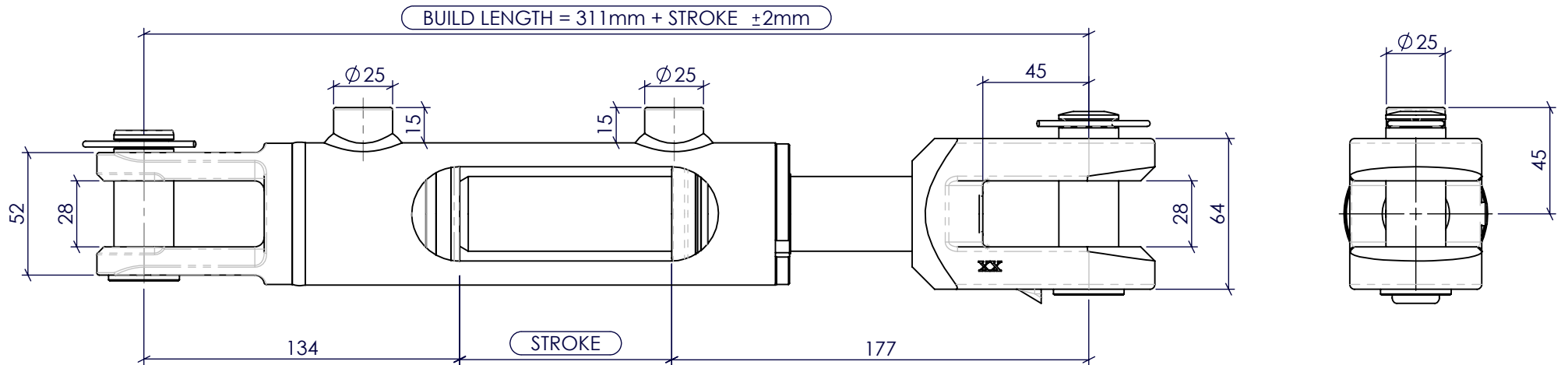
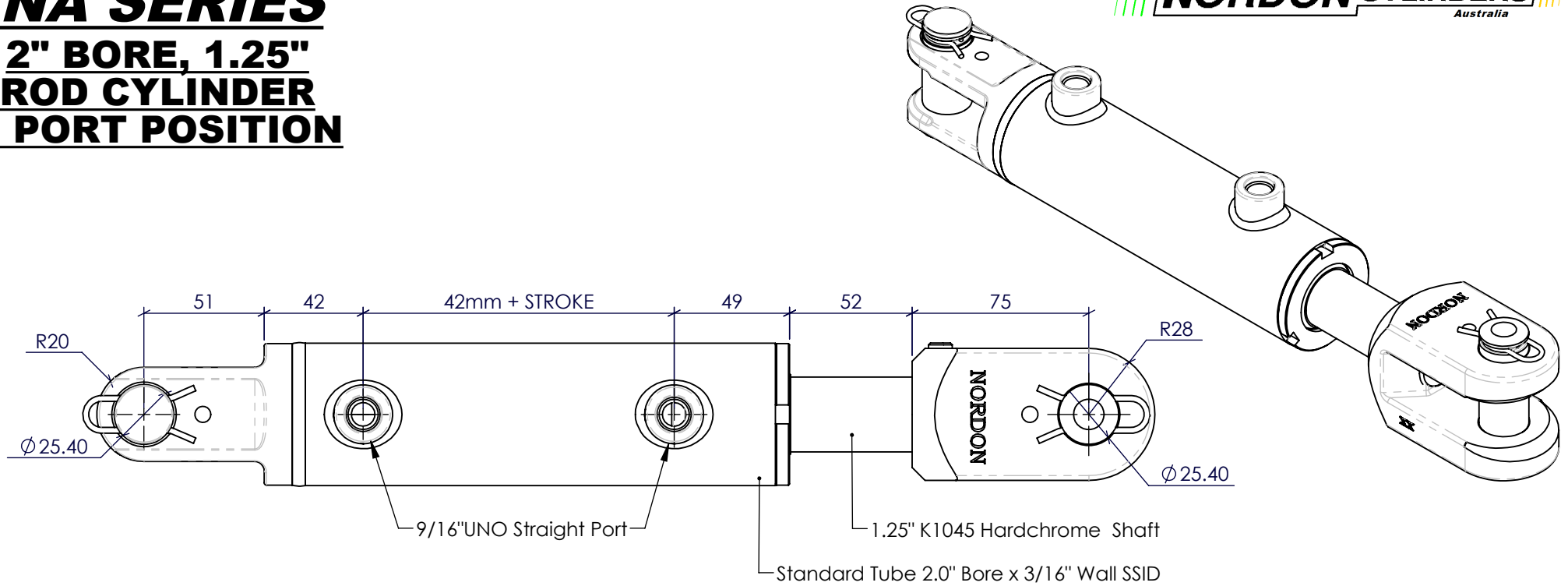

NOTE: ALL THREADS MACHINED TO 2A/B SPECIFICATION.
 ALL PIN HOLES MACHINED TO D9 TOLERANCE.