

NAP SERIES

4.25" BORE, 1.375" ROD, 1.0" PINS REPHASING CYLINDER B PORT POSITION

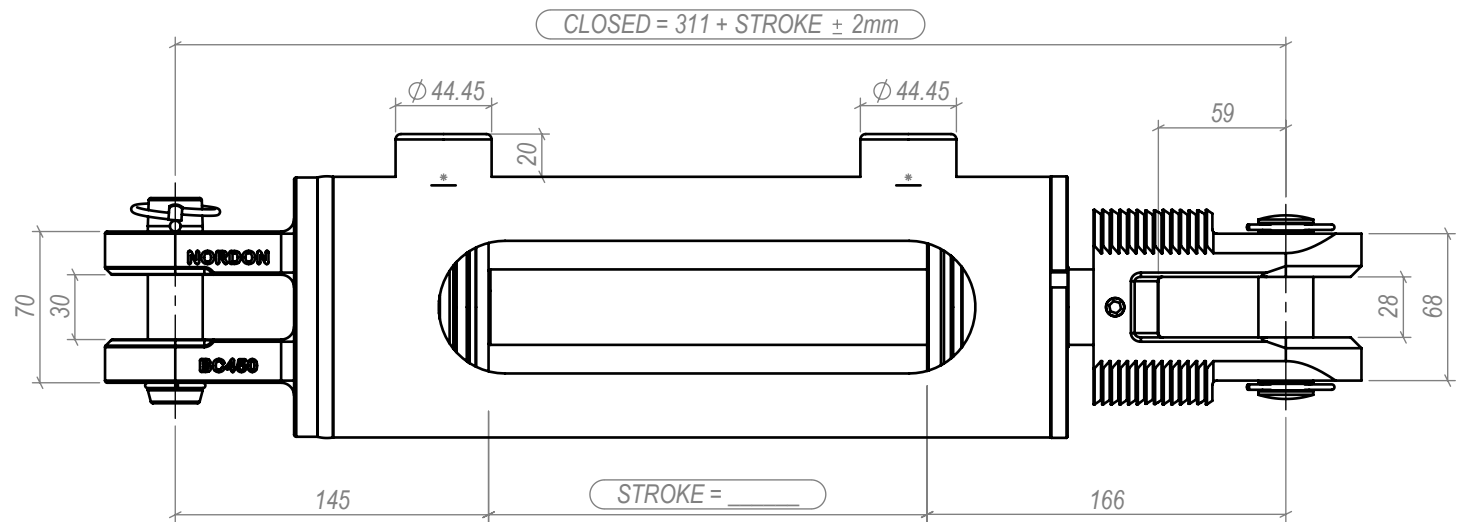
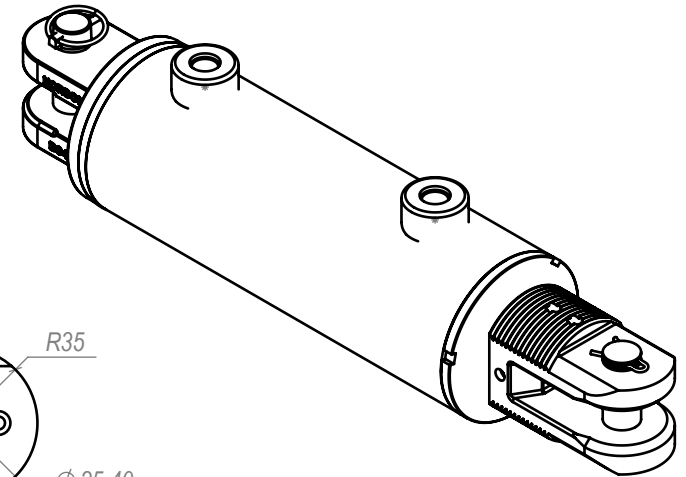
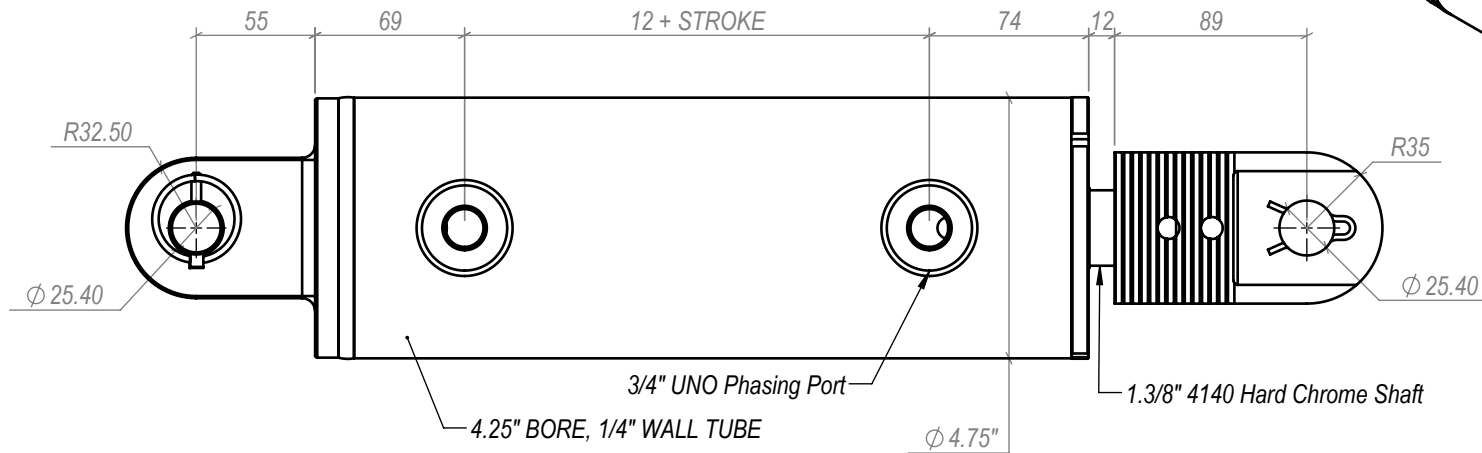

NOTE: ALL THREADS MACHINED TO 2A/B SPECIFICATION.
ALL PIN HOLES MACHINED TO D9 TOLERANCE.

THIS DRAWING AND THE INFORMATION IT CONTAINS IS THE PROPERTY OF NORDON HYDRAULICS PTY LTD
AND MAY NOT BE USED FOR ANY PURPOSE WITHOUT WRITTEN AUTHORISATION FROM THE COMPANY.
DRAWINGS SUBJECT TO CHANGE WITHOUT NOTICE. E&OE